

RUTLAND GUTTER SUPPLY LLC

rutlandguttersupply@yahoo.com Ph: 407-859-1119 Fax: 407-859-1123

LH030

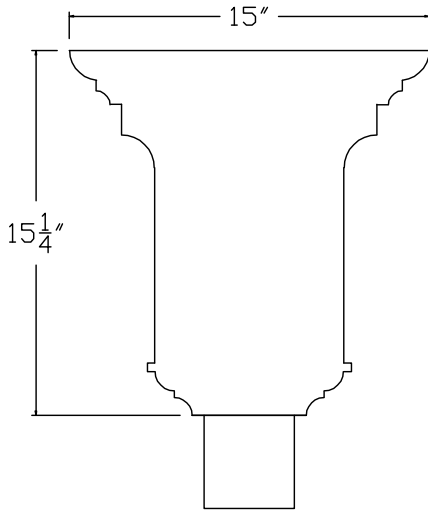

BACK VIEW

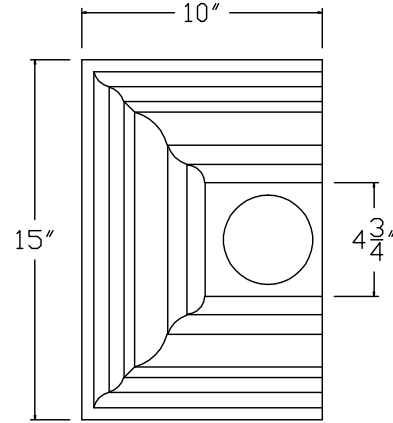

TOP VIEW

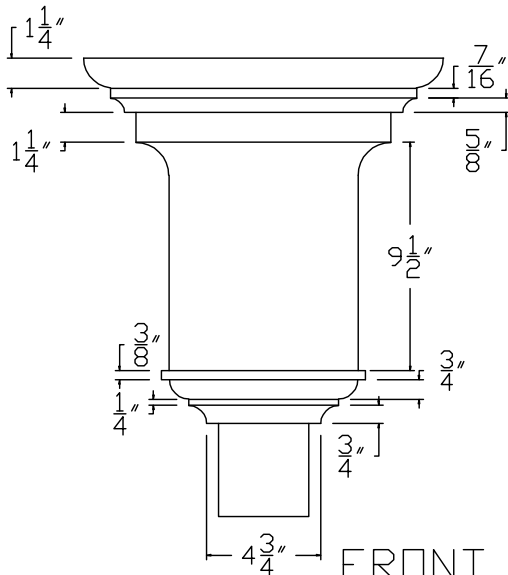

FRONT VIEW

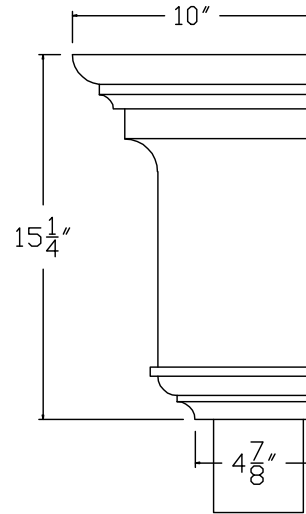

SIDE VIEW

Company:

Item: LH030

Invoice:

Material:

PO#:

Notes:

Architect:

Contractor:

Date:

Approved by:

Signature:

CUSTOM ORDERS CAN NOT BE RETURNED