

RUTLAND GUTTER SUPPLY LLC

rutlandguttersupply@yahoo.com Ph: 407-859-1119 Fax: 407-859-1123

LH014

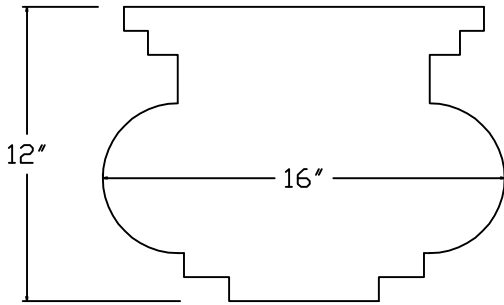

BACK VIEW

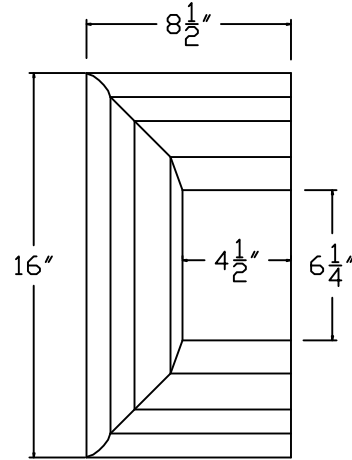

TOP VIEW

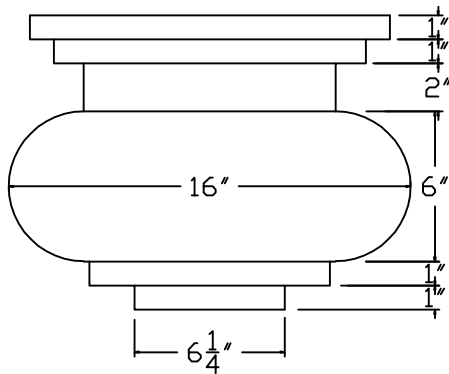

FRONT VIEW

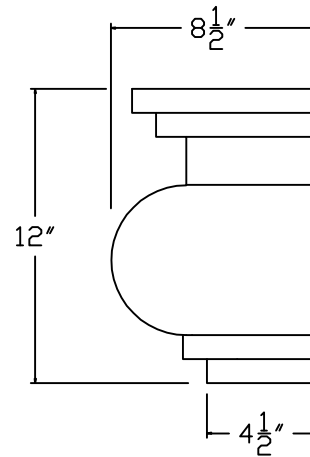

SIDE VIEW

Company:	Item:
Invoice:	Material:
PO#:	Notes:
Architect:	
Contractor:	
Date:	
Approved by:	
Signature:	

CUSTOM ORDERS CAN NOT BE RETURNED